

LAW OFFICES

STORINO, RAMELLO & DURKIN

9501 WEST DEVON AVENUE
ROSEMONT, ILLINOIS 60018

DONALD J. STORINO
MICHAEL K. DURKIN
RICHARD J. RAMELLO
NICHOLAS S. PEPPERS
THOMAS M. BASTIAN
ANGELO F. DEL MARTO
JAMES E. MACHOLL
BRIAN W. BAUGH
ANTHONY J. CASALE
ANDREW Y. ACKER
PETER A. PACIONE
MELISSA M. WOLF
MATTHEW G. HOLMES
MICHAEL R. DURKIN
THOMAS J. HALLERAN

(847) 318-9500

FACSIMILE (847) 318-9509

October 23, 2017

ERIN C. TINAGLIA
ADAM R. DURKIN

JOSEPH G. KUSPER
MARK R. STEPHENS
BRYAN J. BERRY
ANN M. WILLIAMS
LEONARD P. DIORIO
RICHARD F. PELLEGRINO
DONALD J. STORINO II
BRIAN R. KUSPER

OF COUNSEL

IN REPLY REFER TO FILE NO.

EP-1

Ronald T. Anderson
3134 N. 78th Court
Elmwood Park, IL 60707

Re: Freedom of Information Act Request

Dear Mr. Anderson:

On October 17, 2017, the Village of Elmwood Park received your Freedom of Information Act (5 ILCS 140/1 *et seq.*) ("FOIA") request for the following records:

"Ref. Utility Dynamics Corporation letter dated 2/24/2017 Request: see letter (upper right) #17-024 (10 pages)"

Your request has been granted in part and denied in part. Enclosed are records responsive to your FOIA request. However, please be advised that certain information in the records being provided has been determined to be exempt from disclosure under FOIA, and that information has been redacted from the records being provided.

Section 7 (1) (b) of FOIA provides that "private information" is exempt from disclosure. "Private information" is defined in FOIA as, "unique identifiers, including a person's social security number, driver's license number, employee identification number, biometric identifiers, personal financial information, passwords or other access codes, medical records, home or personal telephone numbers, and personal email addresses. Private information also includes home address and personal license plates, except as otherwise provided by law or when compiled without possibility of attribution to any person." 5 ILCS 140/2 (c-5). Consequently, certain unique identifiers, such as signatures have been redacted from the records being provided.

The person responsible for the decision to deny a portion of your FOIA request is the Village of Elmwood Park Freedom of Information Officer, Gina Pesko. In accordance with Section 9(a) of FOIA, you are hereby notified that you have the right to file a Request for Review regarding the decision made by the Village of Elmwood Park Freedom of Information Officer with the Public Access Counselor at the Illinois Attorney General's Office. You can file your Request for Review with the Public Access Counselor by writing to:

STORINO, RAMELLO & DURKIN

Ronald T. Anderson
October 17, 2017
Page 2

Sarah Pratt
Public Access Counselor
Office of the Attorney General
500 South 2nd Street
Springfield, Illinois 62706
Fax: 217-782-1396
E-mail: publicaccess@atg.state.il.us

If you choose to file a Request for Review with the Public Access Counselor, you must do so within 60 calendar days of the date of this letter. Please note that you must include a copy of your original FOIA request and this letter when filing a Request for Review with the Public Access Counselor.

You are also notified that you have the right to judicial review regarding the decision made by the Village of Elmwood Park Freedom of Information Officer pursuant to Section 11 of FOIA.

Sincerely,

STORINO, RAMELLO & DURKIN
Attorneys for the Village of Elmwood Park

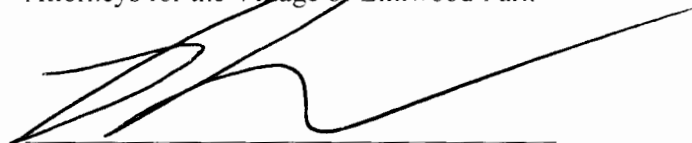
A handwritten signature in black ink, appearing to read 'Peter A. Pacione', written over a horizontal line.

Peter A. Pacione

Enclosures

UTILITY DYNAMICS CORPORATION

23 COMMERCE DRIVE
OSWEGO, ILLINOIS 60543
e-mail: contact@utilitydynamicscorp.com

PHONE:
(630) 554-1722
FAX (630) 554-1195

ELECTRICAL CONTRACTORS • OVERHEAD LINE CONSTRUCTION • UNDERGROUND DISTRIBUTION SYSTEMS

February 24, 2017

#17-024
(10 Pages)

Burke, LLC
9575 W. Higgins Road
Suite #600
Rosemont, IL 60018

Attn: Mr. Orion Galey, P.E.

Subject: Conti Parkway Streetscape
Lighting Plan
Elmwood Park, IL
Proposal – Electrical

Orion:

Utility Dynamics Corporation (UDC) is pleased to Burke LLC (Burke) with our proposal for the above subject additional work. Our scope of work is as follows:

1. Electrical work as shown on Dwg. Sheets 1-3 of 3, dated 2/1/17.
2. A 200A 120/240V service has been included.
3. The lighting controller has been revised to include a 200A service and 200A M/B.
4. One (1) receptacle enclosure to be mounted to the side of the lighting control cabinet, by Excel.
5. One (1) receptacle cabinet to be field installed appx. 150' south of the lighting controller. To include 2" PVC, 3#2 XLP-USE to feed the receptacle cabinet.
6. (3) – 4" x 4" x 4" or 6" x 6" x 6" C.I. junction boxes are included to facilitate connections for the 120V LED strip lighting.
7. Furnish and install LED strip lighting as shown on the electrical drawings.
8. Furnish and install four (4) decorative street lights, foundations and associated conduit and wire; as shown on the electrical drawings.

Our Lump Sum Price to perform the work as specifically described above is \$99,935.00.

The following clarifications are applicable to our proposal:

1. **Pricing is based upon installing the foundations, conduit and handholes after the sidewalks have been removed by others.**
2. **UDC to leave the excess spoils on site, where generated, for removal and disposal by others.**
3. **UDC includes aggregate backfill under hard surfaces (i.e. sidewalk, pavers).**

4. Further coordination will be required to determine how best to route the LED lighting leads thru the masonry work and into the J.B.'s.
5. All work is to be performed during our normal straight time hours.
6. The site shall be fully accessible for our construction activities.
7. UDC is not responsible for damage to or repairs of any unknown or unmarked underground utility/facility; including any private facilities.
8. Vehicular/Pedestrian traffic control and protection is excluded.
9. All restoration is excluded by UDC.
10. Pricing is based upon the work being available for completion prior to the end of summer, 2017.
11. Sales Tax is not included in our pricing.
12. Payment terms are Net 30 days.

Please contact us if you have any questions regarding this proposal.

Sincerely,
Utility Dynamics Corporation



Philip A. Whalen

Encl: (8)

Approved By: _____ (sign)

_____ (print)

Date: _____

This document contains information that is considered confidential or privileged. The information is intended to be for the use of the person or entity named above. Please be aware that any disclosure, copying, distribution or use of the concerns of this document is prohibited.

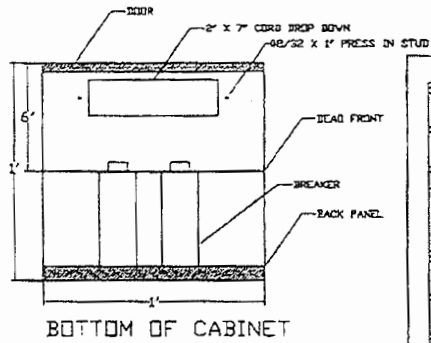

CLOSURE PLATE

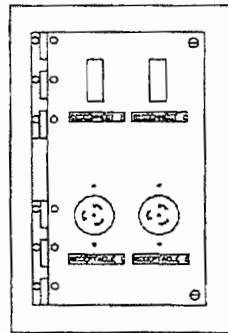

FRONT VIEW DOOR REMOVED

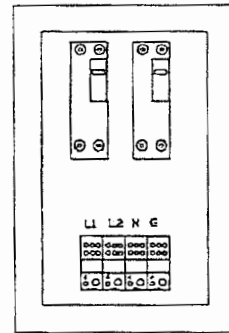

FRONT VIEW DEADFRONT REMOVED

TO BE WIRED WITH 4 CONDUCTOR #6 AWG SOOW CABLE. TWIST LOCK RECEPTACLES TO BE SECURED TO DEADFRONT WITH 8/32 NUT FROM THE BACK. BACK PANEL TO BE 9" W X 15" H MIN.

4" X 9" CLOSURE PLATE TO BE 1/4" THICK AND HELD ON WITH STAINLESS STEEL WINGNUTS. TO BE GASKETED TO ENSURE NEMA RATING.

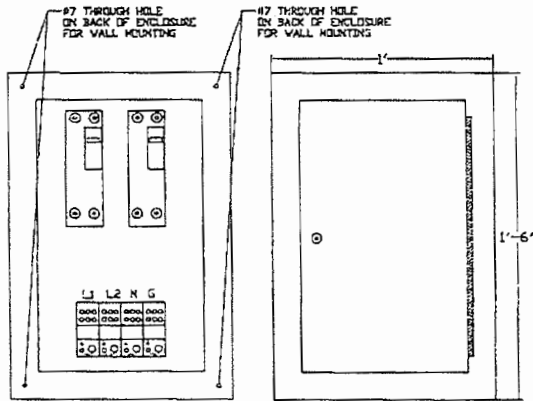

WALL MOUNT RECEPTACLE CABINET

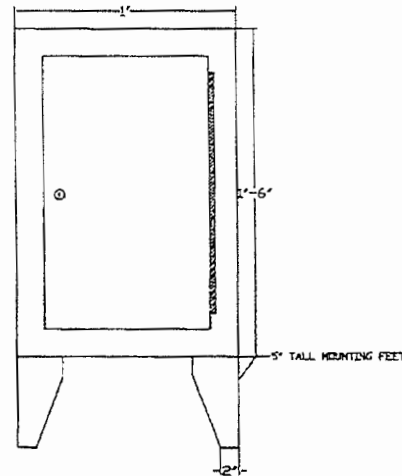

GROUND MOUNT RECEPTACLE CABINET

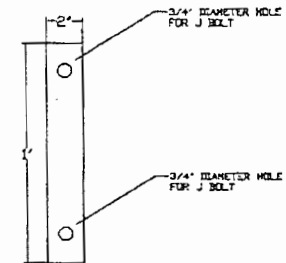

GROUND MOUNT RECEPTACLE CABINET MOUNTING FOOTPRINT

CHICAGO LIGHTWORKS
505 WARRENVILLE ROAD
LISLE 60532

Date:
Project name:
Project Number:

07, February 2017
QQ CHICAGO LIGHTWORKS
FEB 2017
0210109888

Bill Of Material

Thank you for your inquiry.

11 CONTI PARKWAY - VILLAGE OF ELMWOOD - REQUESTED BY COREY ANDERSON

Line #	Quantity	Type	Product and description	P			
10	4 PCE		<p>NEW ITEM NEEDED - HADCO STATEMENT - 912300009320 Brand:Hadco <u>C12607B-A3NND150HE</u> BASED ON C12607-DWG04 REV A - APPROVAL DRAWING REQUIRED FOR ORDER PROCESSING#(T03BCAA2A3ND150HE MOD) MODIFIED W/ LOGO CAGE, (2) ELMWOOD LOGO'S, (2) USA FLAG LOGO'S (2) WHITE, (2) BLUE, (2) RED CAGE PANELS, GFI IN POD / HAGERSTOWN, BLACK COLOR, TYPE 3 OPTICS, MEDIUM SOSCKET, 150W MH, 120V</p>				
20	4 PCE		<p>NEW ITEM NEEDED - HADCO STATEMENT - 912300009320 Brand:Hadco <u>CP12607-14A</u> BASED ON C12607-DWG04 REV A - APPROVAL DRAWING REQUIRED FOR ORDER PROCESSING (P9500-14A) 5" STRAIGHT FLAT FLUTED ROUND ALUMINUM POLE, 14 FT, BLACK COLOR, 3" TENON#NOTE: QUOTED POLE HAS 8"-9" BOLT CIRCLE AND IS NOT ETL/UL LISTED - POLE IS ALSO NOT IDOT APPROVED</p>				
30	4 PCE		<p>NEW ITEM NEEDED - HADCO STATEMENT - 912300009320 Brand:Hadco <u>CA12607A-5A</u> BASED ON C12607-DWG04 REV A - APPROVAL DRAWING REQUIRED FOR ORDER PROCESSING (SLBPT3117-5A) SLIP OVER BASE, 5" POST DIAMETER, BLACK COLOR</p>				
<p>Phillips Lighting Company JESSICA NGUYEN 100 CRAFTWAY DRIVE LITTLESTOWN 17340 UNITED STATES</p>			<p>Number of releases available based on total PO Value as follows: \$10,000 1 Release \$20,000 2 Releases Releases TBD \$50,000 3 Releases \$100,000 4 Releases >\$100,000 # of</p>	<p>Standard Terms of Payment: 1% 10, NET 25 Standard Terms of Delivery: CIP Carriage and Insurance paid to Prepaid Minimum Order Charge of \$100.00 will apply to orders less than \$1000.00</p>			

Bill Of Material

Date: 07. February 2017
 Project name: QQ CHICAGO LIGHTWORKS
 FEB 2017
 Project Number: 0210109888

Line #	Quantity	Type	Product and description				
40	0 PCE		NEW ITEM NEEDED - HADCO STATEMENT - 912300009320 Brand:Hadco CA12607B-A BASED ON C12607-DWG04 REV A - APPROVAL DRAWING REQUIRED FOR ORDER PROCESSING (BA61A30B-A MOD) MODIFIED BREAKAWAY / SINGLE BANNER ARM, 30" ARM LENGTH, 5" POST DIAMETER, BLACK COLOR				
50	4 PCE		NEW ITEM NEEDED - HADCO STATEMENT - 912300009320 Brand:Hadco CA12607C-A BASED ON C12607-DWG04 REV A - APPROVAL DRAWING REQUIRED FOR ORDER PROCESSING (FPB5112-A) SINGLE FLOWER POT BRACKET, 5" POST DIAMETER, BLACK COLOR				
60	4 PCE		T01000684 - 912400128324 Brand:Hadco TEMP,P9400/P9600				
70	4 PCE		41100027 - 912400110297 Brand:Hadco ANCHOR ROD 3/4 OD 4 PER BOX				
Phillips Lighting Company JESSICA NGUYEN 100 CRAFTWAY DRIVE LITTLESTOWN 17340 UNITED STATES			Number of releases available based on total PO Value as follows: \$10,000 1 Release \$20,000 2 Releases Releases TBD \$50,000 3 Releases	Standard Terms of Payment: 1% 10, NET 25 Standard Terms of Delivery: CIP Carriage and Insurance paid to Prepaid Minimum Order Charge of \$100.00 will apply to orders less than \$1000.00			

2/24/17 CALL & EMAIL TO HEIDI TO CONFIRM THIS IS OUTDOOR
 TRAFFIC & INCLUDES CHANNEL, CLIPS & COVER.

KSA

LIGHTING & CONTROLS

Quote

Job Name: Village of Elmwood Park
 Quote #: 17-67180-1
 Quote Label: Line voltage fixture option
 Job Location: Elmwood Park, Illinois
 Issue Date: 2/22/2017
 Good Through: 4/7/2017
 Quoted By: Sprague, Heidi

KSA LIGHTING INC
 1220 CENTRAL AVE
 HANOVER PARK, IL 60133-5420
 (Phn) 630-307-6955 EXT:
 (Fax) 630-307-6965

Quoted To: Whalen, Phil
 Utility Dynamics
 23 Commerce Dr,
 Oswego, IL 60543

Type	Qty	Manufacturer/Brand	Catalog #	Line Comment	Unit \$	Ext \$
				BASED ON (3) 16' RUNS AND (1) 53'		
	48	LLI Architectural Lighting (formerly LED Lighting)	TAC2835-420WW-120VAC-80-PF; WARM WHITE,	(3) 16' runs 120V; 1.8W/FT; PER FOOT		
	52	LLI Architectural Lighting (formerly LED Lighting)	TAC2835-420WW-120VAC-80-PF; WARM WHITE,	52' 120V; 1.8W/FT; PER FOOT REQUIRES 50% DEPOSIT		

Grand Total:

Notes:

- * **PLEASE REFERENCE Q-TRAN'S QUOTE NUMBER WHEN SUBMITTING YOUR ORDER
- **CONTRACTOR, DISTRIBUTOR OR REP TO CONFIRM LENGTHS BEFORE ORDERING
- **LED MAX LENGTH IS 16'; CUT EVERY 2.8"
- **EACH LENGTH OF LED TAPE LIGHT COMES WITH A STANDARD 18" LEAD WIRE UNLESS OTHERWISE REQUESTED
- **PRICING INCLUDES INSTALLATION OF LED IN EXTRUSION
- **EXTRUSION MAX LENGTH IS 98.25"; CUTTABLE TO ANY LENGTH
- **4 CLIPS AND 2 ENDCAPS INCLUDED PER FULL EXTRUSION
- **DIM WITH FORWARD PHASE DIMMER WITH A NEUTRAL WIRE
- **FREIGHT ESTIMATE NOT INCLUDED IN THIS QUOTE
- VARIATIONS TO THIS QUOTE MAY RESULT IN CHANGES TO THE CURRENT PRICING
- **QUOTE GOOD FOR 90 DAYS
- * Lamps NOT Included Except as Noted
- * Manufacturer's Standard Freight Terms and Conditions for Sale Apply
- * Any deviation voids this quote.
- * Alternate Fixtures are not included in the total.
- * Final confirmation of quantities is the responsibility of the contractor.
- * Subject to approval; No plans or specs were provided at bid time.
- * Please reference KSA quote number on purchase order.
- * Luminance testing is not included for all roadway quotations unless otherwise specified in the body of the quote.
- * A set of submittals marked "Approved as Noted", or KSA Release Waiver Form, will be required for all project orders.

PROPOSED SPS FOR
MEASUREMENT

YS Type Unflanged Junction or Pull Boxes

Y Series: Raintight, Watertight, Dusttight

Cast Iron Box For Surface Mounting.

NEC/CEC:
NEMA/CSA Type 1, 2, 3, 3R, 3S, 4, 5, 12, 12K, 13

Applications

- These boxes are listed by Underwriters Laboratories and Canadian Standards Association as Type 4
- They are suitable for use indoors, outdoors, or where subject to rain, dripping or splashing water or hose-directed water.

Features

- Mounting lugs are standard.
- Type YS boxes have a post in each corner and allowances must be made for them when conduit entrances are to be located close to a corner.
- Neoprene gasket – between cover and box.
- Suitable for a variety of applications.
- Wide selection of sizes and locations for drilled-and-tapped and slip-hole conduit entrances.

Standard Materials

- Box and cover: cast iron
- Gasket: neoprene
- Screws: stainless steel

Standard Finishes

- Box and cover: hot dip galvanized

Options

- For additional options see *Ordering Information* pages.

NEC/CEC Certifications and Compliances

- UL Standard: UL 514A, UL 50, UL 50E
- UL Listed: E24824
- CSA Standard: C22.2 No. 40
- CSA Certified: 001472
- CSA Certified: Class II, Division 1 and 2, and Class III

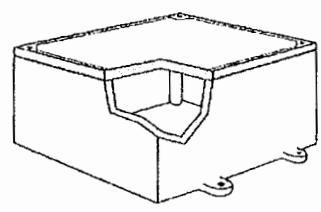
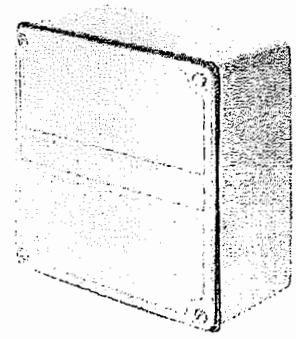

L	Inside Dimensions mm (In)				D	Approximate Wall Thickness \varnothing mm (In)	Iron Catalog Number
	x	W	x				
101.6 (4.00)	x	101.6 (4.00)	x	101.6 (4.00)	6.35 (0.2500)	YS-040404	
152.4 (6.00)	x	152.4 (6.00)	x	101.6 (4.00)	7.94 (0.3125)	YS-060604	
203.2 (8.00)	x	203.2 (8.00)	x	101.6 (4.00)	7.94 (0.3125)	YS-080804	
203.2 (8.00)	x	203.2 (8.00)	x	152.4 (6.00)	7.94 (0.3125)	YS-080806	
254.0 (10.00)	x	254.0 (10.00)	x	101.6 (4.00)	7.94 (0.3125)	YS-101004	
304.8 (12.00)	x	304.8 (12.00)	x	203.2 (8.00)	7.94 (0.3125)	YS-121208	
406.4 (16.00)	x	304.8 (12.00)	x	203.2 (8.00)	7.94 (0.3125)	YS-161208	
457.2 (18.00)	x	304.8 (12.00)	x	254.0 (10.00)	9.53 (0.3750)	YS-181210	
457.2 (18.00)	x	457.2 (18.00)	x	152.4 (6.00)	7.94 (0.3125)	YS-181806	
457.2 (18.00)	x	457.2 (18.00)	x	304.8 (12.00)	11.11 (0.4375)	YS-181812	

\varnothing Measured 50.8 mm (2.00") up from back of box.







Visit our website at www.ozgedney.com or contact us at (800) 621-1506.
© October 2015

ENCLOSURES AND JUNCTION BOXES: ORDINARY LOCATION JUNCTION BOXES

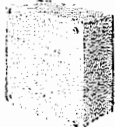
Enclosures and Junction Boxes

Cast Iron Junction Boxes

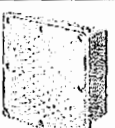
ENCLOSURES AND JUNCTION BOXES: ORDINARY LOCATION JUNCTION BOXES

	Enclosure Style		Type 1 Type 5	Type 2	Type 3 Type 3R Type 3S	Type 4	Type 6	Type 12 Type 12K Type 13
	YS	Surface Mounted	✓	✓	✓	✓		✓
	YL	Surface Mounted	✓	✓	✓	✓		✓
	YF	Surface Mounted	✓	✓	✓	✓	✓	✓
	YW	Surface Mounted	✓	✓	✓	✓		✓
	YR	Flush Mounted	✓	✓	✓	✓		✓
	YU	Flush Mounted	✓	✓	✓			✓
	YT	Sidewalk Boxes	✓	✓	✓	✓		✓
	Y58E	Sidewalk Boxes	✓	✓				

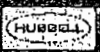

RACO TAYMAC BELL

www.hubbell.com

MASONRY BOXES & PARTITIONS

Masonry Boxes, 3-1/2 In. Deep - Nongangable with Conduit I/O's
2-Gang, 3-25/32 In. Wide

A68

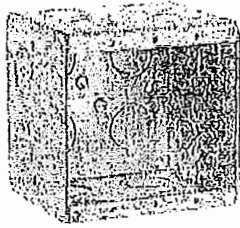

- OPTION TO CAST IRON
- PAINT STEEL COVER
PLATE

Catalog #: 696

APPLICATIONS

RACO's Masonry boxes are designed to accommodate the mounting of switches or other devices in masonry walls. 2-1/2" deep boxes are used in 4" block walls, 3-1/2" deep boxes are used in 6" or 8" block walls.

PRODUCT FEATURES

Rugged welded design does not fall apart during construction
Available from one to six gang configurations in both 2-1/2" and 3-1/2" depths
Rectangular shape fits square cuts in block
Large volume design allows for additional work room inside the box
Standard 1/2" and 3/4" concentric knockouts
Device ears inside the box prevent mortar from getting in the device holes
Steel voltage partition #971 fits all 2-1/2" or 3-1/2" depths
Standard wall plates can be used
N/A

UL LISTED

File E195978

COMPLIANCES

MSDS
[www.hubbell-rtb.com/certifications/hubbell-RACO MSDS for Steel Boxes and Covers.pdf](http://www.hubbell-rtb.com/certifications/hubbell-RACO%20MSDS%20for%20Steel%20Boxes%20and%20Covers.pdf)

GENERAL PRODUCT INFORMATION

Wiring System: Conduit

CONFIGURATION

End Knockouts: 0 Conc.
Drawn or Welded: Welded
Gangs: 2
Side Knockout(s): 12 Cono.
Bottom Knockouts(s): 4 Conc.

DRAWING DIMENSIONS

Dimension A: 3-1/2 in.
Dimension B: 3-25/32 in.

PRODUCT MEASUREMENTS

Depth: 3-1/2 in.
Cubic Inches (cm³): 45.0 (737.4)
Wt Ea. (Lbs.): 1.104
Product Length (in.): 3.50
Product Width (in.): 3.75
Product Height (in.): 3.70

PACKAGING

Minimum Pack Qty.: 25
Std. Pkg.: 25
Product UPC-A Labeled: Yes
Weight (Lbs. Per/C): 118.40
Ship Carton Length (in.): 18.13
Ship Carton Width (in.): 7.88
Ship Carton Height (in.): 11.03
Ctn Weight (Lbs.): 29.00
Pallet Qty.: 1350
UPC Number: 050100006062
12of6: 60960189006967